

UST 85

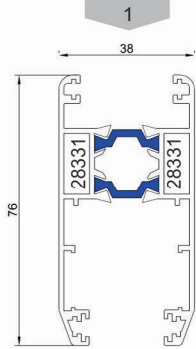

پروفیل لنگه
 Vent profile
 Code : 28331-28331
 weight : 1.51 kg/m

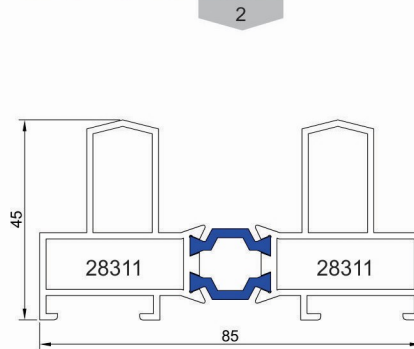

پروفیل فریم
 Frame profile
 Code : 28311-28311
 weight : 1.65 kg/m

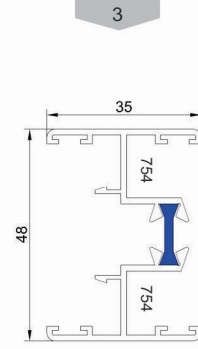

واسطه ۴ لنگه
 The Middle of four Vent
 Code : 754-754
 weight : 0.75 kg/m

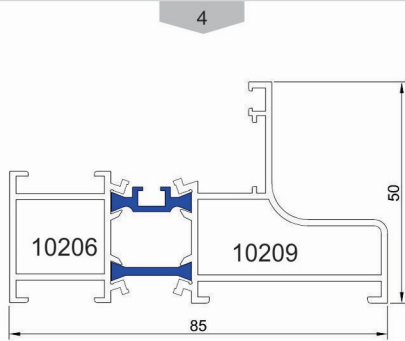

پروفیل فریم
 Frame profile
 Code : 10206-10209
 weight : 1.42 kg/m

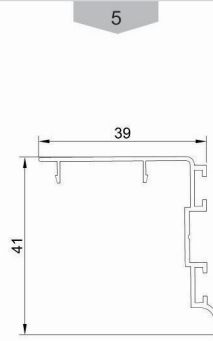

درپوش
 gap
 Code : 28321
 weight : 0.27 kg/m

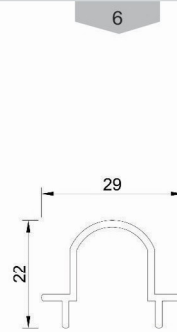

پروفیل وسط ۲ فریم
 The middle of two Frame
 Code : 753
 weight : 0.24 kg/m

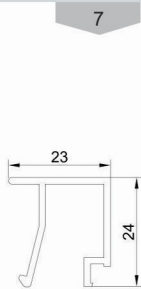

زهوار ۲ جداره ترمال
 Double rickety
 Code : 21351
 weight : 0.3 kg/m

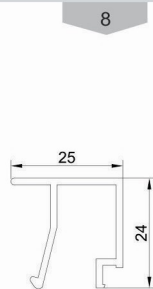

زهوار ۲ جداره ترمال
 Double rickety
 Code : 21352
 weight : 0.31 kg/m

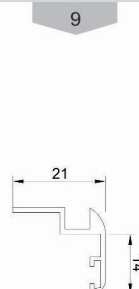

روکوب ۱۴
 Suppressed the binding
 Code : 10021
 weight : 0.2 kg/m

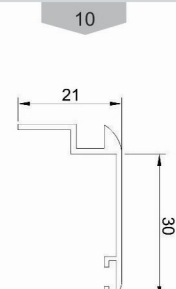

روکوب ۳۰
 Suppressed the binding
 Code : 10022
 weight : 0.22 kg/m

UST 85

11

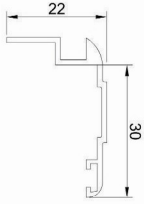

روکوب ۳۰

Suppressed the binding

Code : 10023

weight : 0.23 kg/m

12

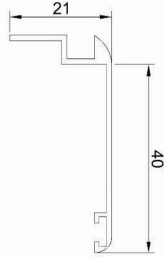

روکوب ۴۰

Suppressed the binding

Code : 10024

weight : 0.25 kg/m

13

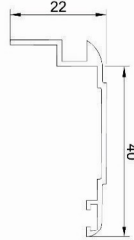

روکوب ۴۰

Suppressed the binding

Code : 10025

weight : 0.26 kg/m

14

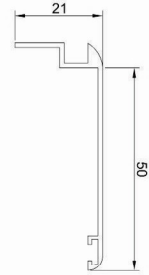

روکوب ۵۰

Suppressed the binding

Code : 10026

weight : 0.28 kg/m

15



روکوب ۵۰

Suppressed the binding

Code : 10027

weight : 0.29 kg/m